



HAL
open science

IEA SHC Task 42 / ECES Annex 29 – Working Group B: Applications of Compact Thermal Energy Storage

Wim van Helden, Motoi Yamaha, Christoph Rathgeber, Andreas Hauer,
Fredy Huaylla, Nolwenn Le Pierrès, Benoit Stutz, Barbara Mette, Pablo
Dolado, Ana Lázaro, et al.

► To cite this version:

Wim van Helden, Motoi Yamaha, Christoph Rathgeber, Andreas Hauer, Fredy Huaylla, et al.. IEA SHC Task 42 / ECES Annex 29 – Working Group B: Applications of Compact Thermal Energy Storage. Energy Procedia, 2016, 91, pp.231 - 245. 10.1016/j.egypro.2016.06.210 . hal-01833458

HAL Id: hal-01833458

<https://univ-smb.hal.science/hal-01833458v1>

Submitted on 5 May 2021

HAL is a multi-disciplinary open access archive for the deposit and dissemination of scientific research documents, whether they are published or not. The documents may come from teaching and research institutions in France or abroad, or from public or private research centers.

L'archive ouverte pluridisciplinaire **HAL**, est destinée au dépôt et à la diffusion de documents scientifiques de niveau recherche, publiés ou non, émanant des établissements d'enseignement et de recherche français ou étrangers, des laboratoires publics ou privés.



Distributed under a Creative Commons Attribution - NonCommercial - NoDerivatives 4.0
International License



SHC 2015, International Conference on Solar Heating and Cooling for Buildings and Industry

IEA SHC Task 42 / ECES Annex 29 – Working Group B: Applications of compact thermal energy storage

Wim van Helden^{*,1}, Motoi Yamaha², Christoph Rathgeber³, Andreas Hauer³, Fredy Huaylla⁴, Nolwenn Le Pierrès⁴, Benoit Stutz⁴, Barbara Mette⁵, Pablo Dolado⁶, Ana Lazaro⁶, Javier Mazo⁶, Mark Dannemand⁷, Simon Furbo⁷, Alvaro Campos-Celador⁸, Gonzalo Diarce⁸, Ruud Cuypers⁹, Andreas König-Haagen¹⁰, Stephan Höhlelein¹⁰, Dieter Brüggemann¹⁰, Benjamin Fumey¹¹, Robert Weber¹¹, Rebekka Köll¹, Waldemar Wagner¹, Xavier Daguenet-Frick¹², Paul Gantenbein¹², Frédéric Kuznik¹³

¹AEE INTEC, Feldgasse 19, 8200 Gleisdorf, Austria; Phone: +31 6 2014 3224,

^{*}corresponding author. E-mail: w.vanhelden@ae.at;

²Chubu University, Nagoya, Japan; ³ZAE Bayern, Garching, Germany; ⁴LOCIE Laboratory, CNRS-Savoie Mont Blanc University, France;

⁵ITW, University of Stuttgart, Germany; ⁶University of Zaragoza, Spain; ⁷DTU Technical University of Denmark; ⁸University of the Basque Country, UPV-EHU, Spain; ⁹TNO, Delft, the Netherlands; ¹⁰University of Bayreuth, Germany; ¹¹EMPA, Dübendorf, Switzerland; ¹²HSR-SPF, Rapperswil, Switzerland; ¹³Université de Lyon, INSA-Lyon, CETHIL, Villeurbanne, France;

Abstract

The IEA joint Task 42 / Annex 29 is aimed at developing compact thermal energy storage materials and systems. In Working Group B, experts are working on the development of compact thermal energy storage applications, in the areas cooling, domestic heating and hot water and industry. The majority of application projects were in the field of room heating and domestic hot water. In this article, an overview is given of a large number of applications. The storage technologies used in the applications are latent heat storage, open and closed solid sorption, liquid sorption and salt hydrates and composites thereof. On a broad front, a lot of progress was made in the development of components and systems, providing knowledge and experience regarding the design, numerical modeling, building, testing and economical assessing of components and storage systems. Most important findings are that the interaction of storage materials with the materials of components can be deciding for the technical feasibility, that a number of components, like reactor, heat exchangers and evaporators are less understood than initially thought and need more development, that the inclusion of storage materials in systems generate new challenges like the occurrence of non-condensable gases and thermo-mechanical effects and that standardized and simplified system approaches are needed.

© 2016 Published by Elsevier Ltd. This is an open access article under the CC BY-NC-ND license (<http://creativecommons.org/licenses/by-nc-nd/4.0/>).

Peer-review by the scientific conference committee of SHC 2015 under responsibility of PSE AG

Keywords: thermal energy storage, applications; PCM; TCM;

1. Introduction

Within the Working Group B (Applications) of the IEA joint Task 42 /Annex 29, a large number of experts from more than 20 research organisations work on applications of compact thermal energy storage technologies. Application fields are cooling, room heating/domestic hot water and thermal storage for industry. The main challenges in the development of applications are in finding an optimal connection between the storage material and the other materials, the components and the system configuration. The problems to be solved are in the area of materials compatibility, like corrosion protection, prevention of side reactions and cycling stability; in the area of component design, with heat and mass transfer optimisation; and in the area of system design with control strategies and cost minimisation.

Thermal storage for cooling applications is the most advanced. There are numerous examples of ice storage systems, running to get a higher system performance or to enable a shift of electricity consumption from daytime to nighttime. Challenges in these systems are the integration of novel PCM with somewhat higher melting temperatures than water and the system optimisation in connection with electricity grids and heating networks.

Most application developments in T4229 are in the area of thermal energy storage for room heating and domestic hot water preparation. Here, there is a broad collection of storage technologies and system concepts being developed and tested. Phase change materials and thermochemical materials are applied as active material in open and closed systems.

A third field of application is in the transportation of residual or waste heat to a remote user by compact thermal storage technologies. Due to scaling effects, this application is first developed for industrial users.

In the Task 42 / Annex 29, special attention is paid to the collaboration between materials researchers and system engineers. A compact thermal energy storage material only has value in a certain application, and the application will imply certain design conditions on the storage material. A first step towards a better collaboration and interaction is for system engineers to understand how materials researcher evaluate the properties of a storage material, and for materials experts to understand the practical implications of integrating material into a storage system. In the Task, work is done to couple the material properties to system performance, although this in most cases is far from straightforward. For sorption storage technologies, an approach was set up using 4 typical operating temperatures with which the operation boundary conditions are determined and the performance of a storage material in an application can be determined [1].

Given a certain application, it is necessary to have a common basis for determining the performance of different storage technologies. To this end, a design has been made of a set of Key Performance Indicators KPI's of compact thermal energy storage for seasonal storage. In future, these KPI's will be a valuable tool for comparison of different thermal storage concepts.

In the next chapters, a number of developments that were undertaken by experts from the Task 42 /Annex 29 are shortly described. Although numerous, these are not all the system concepts or technologies developed in connection to the Task. They give, however, a good view of all the developments presently underway including the challenges that are connected to them.

2. Low temperature storage applications

In the Task 42 /Annex 29 the division between application areas was determined by the typical operational temperature ranges: low, medium and high temperature. A low temperature, the typical application is cooling, with temperatures below 20 °C. Medium temperature applications are room heating and domestic hot water, with temperatures between 20 °C and 100 °C. Above 100 °C, the industry applications are situated.

Two developments in the low temperature application field will be described: a latent heat storage in a solar thermally driven cooling and heating system, and a very large ice storage system for building cooling in Japan.

2.1. Solar heating and cooling with absorption chiller and latent heat storage; ZAE Bayern

The latent heat storage is integrated into a thermal solar heating and cooling system and supports the dry air cooler in the heat rejection system on hot days during summertime to ensure a constant cooling water return temperature of 32 °C. The charged heat is dissipated to the ambient during off peak hours or nighttime when more favorable ambient conditions are available. In wintertime the latent heat storage serves as an additional low temperature storage to buffer solar surplus at constant storage temperatures, leading to low collector temperatures and thus high solar gain. Calcium chloride hexahydrate with a melting temperature of about 29 °C is used as PCM and a propylene glycol - water mixture as heat transfer medium [2].

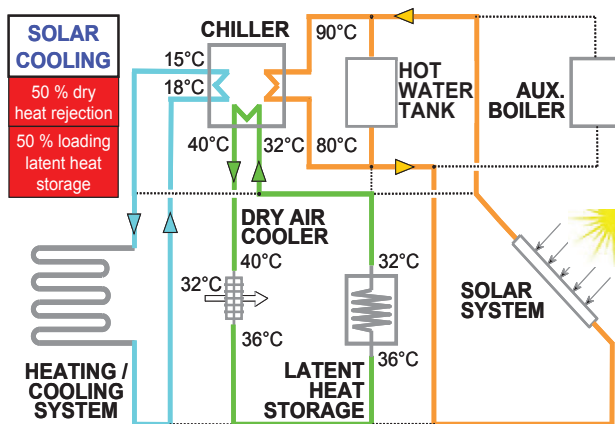

Fig. 1: System scheme of the solar heating and cooling installation at ZAE Bayern

The heat storage material (Calcium chloride hexahydrate) has a volume of 1 m³, and the gross volume incl. the storage container accounts for 1.9 m³. The realized storage capacity between 22 and 36 °C is 83 kWh. In the case of discharging, 14 kW peak power can be extracted from the storage.

During the monitoring period the two latent heat storage modules have undergone over 800 loading and unloading cycles under real conditions. Due to the use of the latent heat storage the cooling water return temperature did not exceed 33.5 °C despite dry air cooling and ambient temperatures above 32 °C. In heating mode about 15 % of the overall heat demand has been provided by the latent heat storage.

2.2. Cooling of building; Nagoya Station; Chubu University

Ice thermal storage systems have been popular thermal energy storage systems in Japan since mid-90s. More than 10 thousand systems varying from small ones to huge ones are installed. This example is a district heating and cooling (DHC) facility for an area where the world's largest station building is situated. This DHC adapts the Eco friendly heat supply system which saves energy by combination of "Ice storage system (electricity)" and waste heat from the "Cogeneration system (Natural gas)". Energy management is adopted to enhance energy efficiency by continuous analysis of operational data.

As cooling demand in the summer time is at a high plateau from 11:00 to 18:00, by discharging the cold heat stored at night time, the system could reduce the operation hours of the chillers and contribute to energy saving. The electricity demand curve resulted to be flat. Its value is around 3 to 4 MW contributing to load levelling and reduction of operational cost.

The objective of the system is to shave the peak to off-peak hours and take advantage of the tariff difference between day and night. By producing ice at night time utilizing low cost night time electricity and using it to produce cold water in the daytime, this Ice Storage System contributes to cost reduction and load levelling. The facility has ice storage tanks of 1,266 m³ with 49GWh capacity.

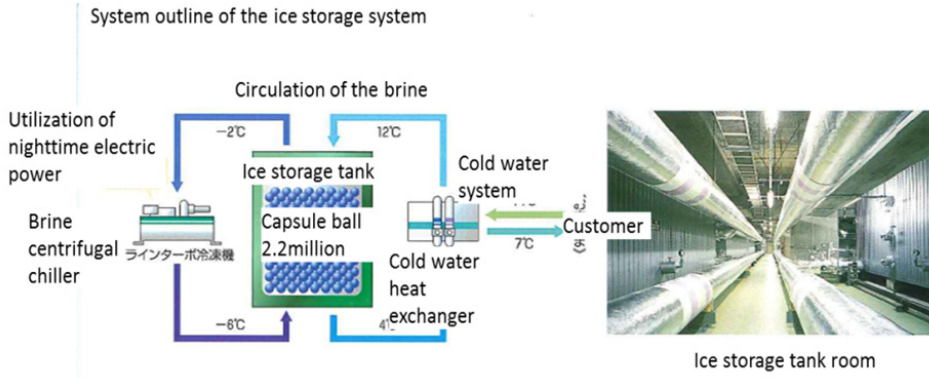

Fig. 2: Schematic diagram of the ice tank storage system and photo of the storage tank room

3. Medium temperature storage applications

Typically, the medium temperature applications have the function to provide room heating, domestic hot water or both. In this area, most developments take place with a variety of storage technologies. These range from phase change, solid and liquid sorption to salt hydrate systems.

3.1. Closed absorption system with sodium hydroxide; EMPA and HSR-SPF

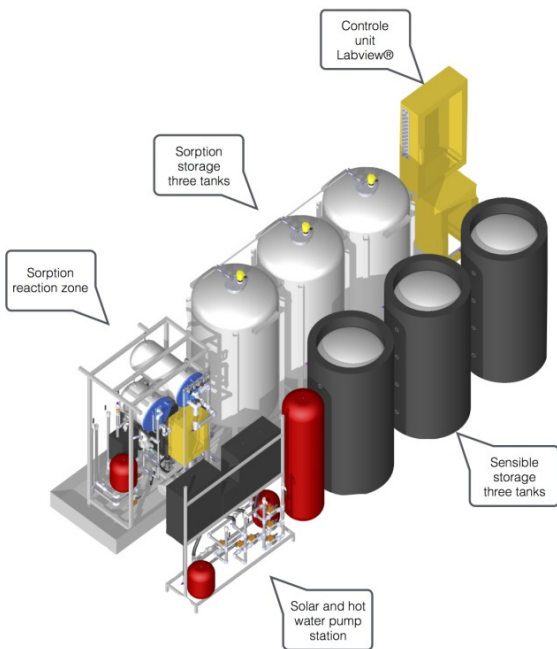

Fig. 3: CAD picture of the hybrid system indicating components and function.



Fig. 4: Picture of the demonstrator heat and mass exchanger connected to the storage tanks.

In Line B of the EU financed project COMTES a heat storage system based on absorption of vapor by a liquid in a closed process is developed. The working pair is aqueous sodium hydroxide (NaOH-H₂O) and water. In the project a demonstrator was built, functioning as a hybrid system [3]. It is composed of hot water tanks as sensible heat storage for short term storage of several days and an absorption heat storage unit for long term storage of weeks and months. The complete system is built into a shipping container on which solar thermal vacuum tube collectors are installed for solar heat harvesting. The absorption system consists of a power unit in the form of a heat and mass exchanger connected to a capacity unit made up of three tanks containing the sorbent NaOH-H₂O in its charged and discharged state as well as the sorbate water. Sorbent and sorbate are pumped to and from the heat and mass exchanger with gear pumps in both the charging and discharging process steps.

The design of the required heat and mass exchanger for desorption and absorption has proven to be challenging. For the sake of a compact build, a single unit for both process steps was pursued [4]. The falling film tube bundle approach followed in this development has shown poor power performance in the absorption (discharging) process [5]. In contrast to this, in the desorption (charging) process power performance according to design calculations was reached. Nevertheless the desired concentrations in absorption as well as desorption were not reached. This is essential for a high system energy density. In the continuation of this work, the concept of a single unit combining the discharging and the charging process steps has to be reconsidered and possibly rejected. In case of the combined evaporator and condenser unit the concept can be followed.

3.2. Solid sorption solar seasonal storage; AEE INTEC, ITW, TH Wildau, Vaillant

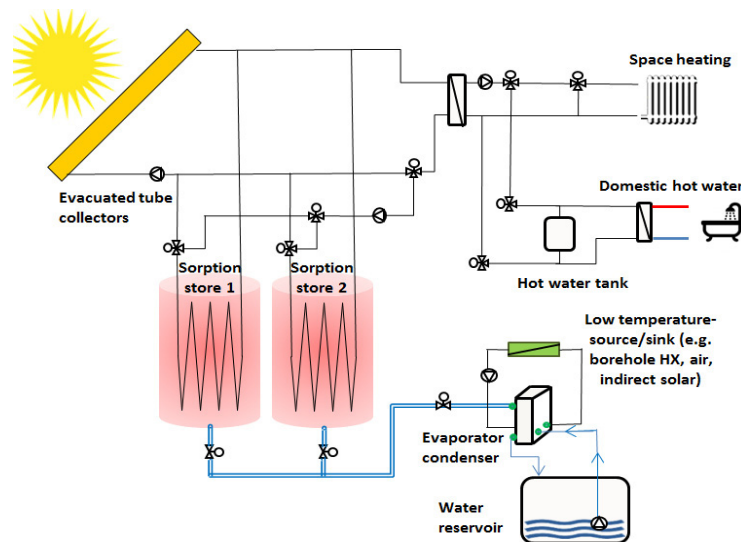

Fig. 5: System schematic of the seasonal solar thermal storage system at AEE INTEC.



Fig. 6: Picture of the PROSSIS2 prototype: in front, the water storage tank, in glass: the solution storage tank, above: the reactor

In the EU funded project COMTES, in Development Line A, a system is developed, tested and optimized that is based on closed sorption of a solid material. The used working pair is zeolite 13XBF and water. In a first phase the heat and mass transfer in a prototype vessel with about 180 kg of zeolite was numerically modeled and experiments were carried out to validate the model. With this model, the heat exchanger geometry for the two larger vessels (each 1000 liters, 705 kg zeolite) was optimized. The system was built up, containing also 16 m² of vacuum tube solar collectors, an evaporator/condenser heat exchanger and a separate vessel to contain the condensed water. During the system tests, a computer model emulates the actual heating and domestic hot water demand of a single family house, using the actual weather data and a standard tap water pattern. With the experimental system set up,

different control strategies have been tested and a number of parameters (mostly heat loss coefficients) of the system have been determined. The first tests revealed a record storage density for this size of storage of 180 kWh/m³ of bulk material. Since October 2015, a half-year test is started with fully charged vessels, with the aim to assess the system performance in ‘winter’ mode.

In the design and experiments of the storage system, it became clear that one of the major items that need further research and optimisation is the evaporator/condenser unit. Especially the evaporation process of water under low pressures is still too little understood.

3.3. PROSSIS2, LOCIE laboratory, CNRS-USMB

This experimental study develops a closed absorption process using LiBr-H₂O solution for building space heating. The developed system is composed of a reactor and two tanks, one to store the liquid LiBr solution and the other to store liquid water (Fig. 6). It functions at low pressure, around 10 mbar. The system works in a discontinuous process (charge in summer and discharge in winter), consequently two reversible flat falling-film heat exchangers are situated inside the reactor where one heat exchanger operates as a desorber and the other as a condenser in the charging period or as an absorber and an evaporator in the discharging period, respectively [6], 7]. Experimental tests have been carried out using a solution volume of 60 litres and covering a concentration range between 54% and 60% [mLiBr/mSol]. Results indicate that a heating power of up to 1.5 kW can be obtained in the discharging mode (Fig. 7). An optimization of the system performance is envisaged through the improvement of the liquid wetting at the heat exchanger surfaces since in the described tests the percentages of wetted surface were between 30% and 70%. Tests conditions at higher concentrations will be experimented, to weigh the interest of crystallisation of the solution in the storage tank on the storage density. Other working couples will also be tested, as LiBr is quite expensive and could certainly not be used in a real-scale system.

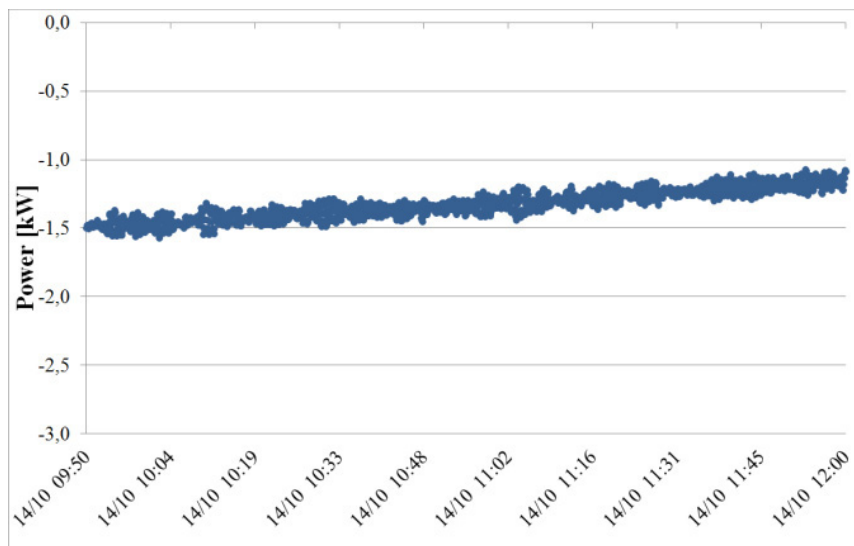

Fig. 7: Example of the exchanged power between the heat transfer fluid and the absorber, during a discharging phase.

3.4. Thermochemical storage demonstration system for space heating and DHW; MERITS project, TNO

MERITS is an R&D project supported by the European FP7 program with the aim to build a prototype of a compact rechargeable thermal battery. Such a product would offer a new solution for improved use of renewable sources for domestic heating, cooling and hot water appliances and thus greatly contribute to the European ambition of an energy-neutral built environment by 2050.

The project is carried out by four research institutes (TNO, VITO, Tecnalia, Fraunhofer ISE), two universities (Ulster University, University of Lleida), two SME's (De Beijer RTB, Zonne-Energie Nederland BV), and two industries (Mostostal, Glen Dimplex). The team works with novel high energy density thermochemical materials that can supply required heating, cooling and domestic hot water for a dwelling with up to 100% renewable energy sources (e.g. the sun) throughout the year. The key development issues are:

- The delivery of heat on different dedicated temperature levels for heating, cooling and domestic hot water
- The tailoring to the requirements of individual dwellings
- The design and development of a dedicated solar collector
- The integrated design for the components and enhanced thermo-chemical materials, including the control system

Currently, the prototype of the MERITS setup [8] is being assembled in Warsaw for demonstration of a fully functional compact rechargeable heat battery (based on Na_2S as working salt hydrate [9]), including heating, cooling and domestic hot water (Fig. 8). Furthermore the project includes the development of business models and market strategies to foster market take-up before 2020. More information on MERITS is available on the public website “www.MERITS.eu”.

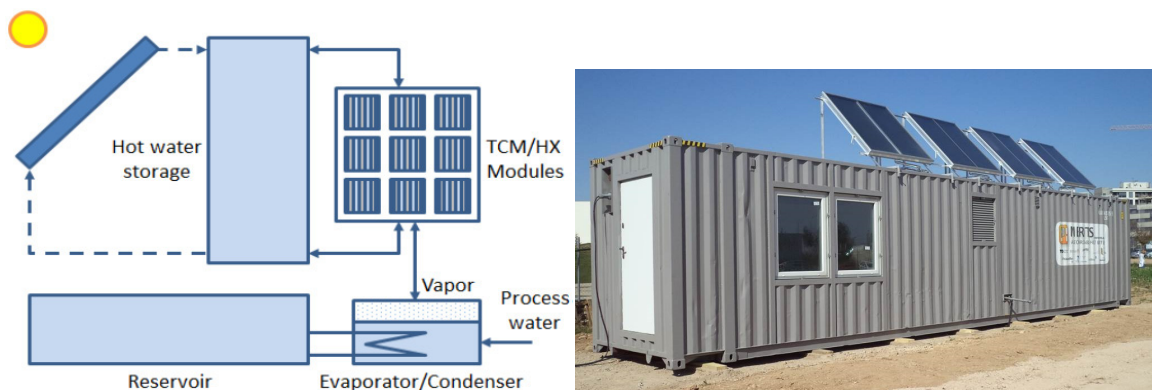

Fig. 8: MERITS system setup (left) and MERITS heat battery demonstrator container (right) at the University of Lleida

3.5. FlowTCS, ITW University of Stuttgart

A long term thermal storage based on an open sorption process with zeolite and salt impregnated zeolite has been developed, set up and tested on a test rig. The sorption storage is characterized by an external reactor concept. A separation is made between the reactor with approximately 30 l of zeolite storage material and the material storage reservoir (in lab test: 200 l storage material volume). This concept enables a high flexibility concerning storage capacity (defined by the size of the material storage reservoir) and thermal power (defined by the reactor operation). The reactor (Fig. 9) is designed as a quasi-continuous cross flow reactor. The storage material slowly flows down through the reactor led by gravity. Via a rotary feeder, which controls the mass flow through the reactor, the storage material is discharged. The air flows in cross flow to the material and transports the heat and water vapour into or out of the reactor. During discharge of the sorption storage the heat released in the reactor is transported to the heating system / buffer store via an air to water heat exchanger. For charging of the sorption storage the air is heated up in the air to water heat exchanger. The heat is delivered by solar thermal collectors or any other heat source. An air to air heat exchanger is integrated into the reactor unit for heat recovery.

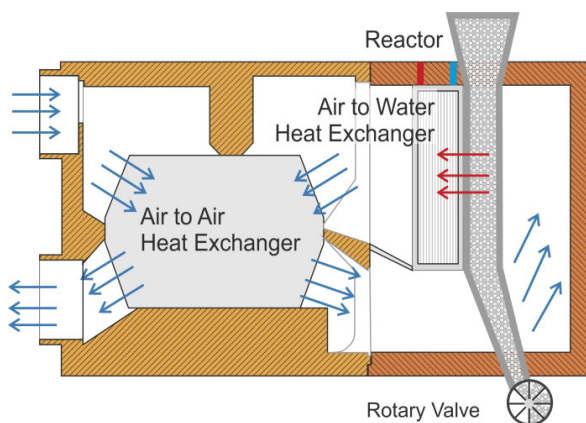

Fig. 9: Reactor unit of the sorption storage: discharging mode

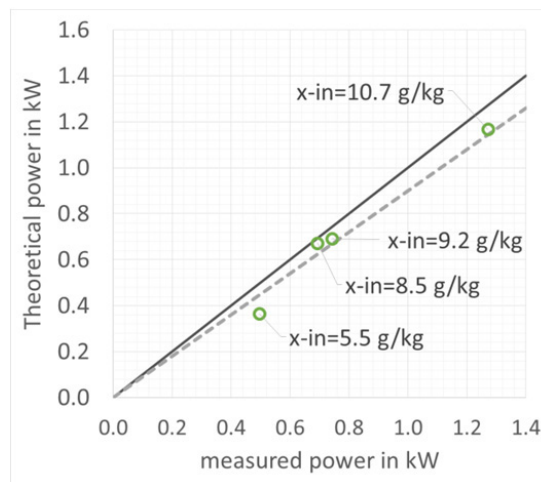

Fig. 10: Thermal power delivered to the heating system as a function of the theoretical thermal power

The charge and discharge of the developed sorption storage has been investigated on a so called Hardware In the Loop (HIL) test rig. The charge and discharge process was operated fully automatically (e.g. the control and regulation of the material and air flow). Zeolite and salt impregnated zeolite beads have been used as storage material. Different experiments have been conducted by varying the humidity of the air flow (5 g/kg ... 11 g/kg) and by varying the heat demand of the heating system (400 W ... 1400 W), see Fig. 10. The high thermal performance of the sorption storage could be demonstrated: The temperature lift observed inside the reactor and the thermal power delivered to the heating system are close to the theoretical values. Furthermore, when leaving the reactor, the material was completely loaded (discharge of the sorption storage) or regenerated (charging of the sorption storage). Hence, the energy storage density of the material was fully utilised. The first results show the high potential of the developed storage concept. Research is ongoing to further optimize the sorption storage (e.g. more compact, less heat losses and lower charging temperature) and to proof the concept in a demonstration plant.

3.6. STAID project, Seasonal Thermochemical Heat Storage in Buildings; CETHIL

Electric peak load is an important problem for electricity suppliers in industrial countries. In France, the critical peak load lasts about 2 h, at the end of the day, between 18 h and 20 h. The use of a storage system during consumption peaks, by punctual discharges, contributes to smooth the load curve and avoids the use of the most polluting power plants throughout the peak.

The purpose of the system developed in this study is to shave the peak by reducing the heating part of the demand. The heat required for space heating depends on the building location and constructive mode. But, relying on standards, it is possible to evaluate the maximum peak load for a low energy building. Focusing on Europe, it is possible to evaluate the mean values of the peak load for space heating, i.e. 20 W m⁻² for a low energy building. Assuming a single-family house of 100 m², the specification requirements for the heat released is 2 kW during 2 h equivalent to 4 kWh of energy stored.

The thermal energy storage system (TESS) will be integrated in the ventilation system of the building. Thus, the TESS is designed to be an open-system. The principle of the system integration is given in Fig. 11. During desorption (i.e. charge), air coming from the building or from outside is heated using a heat source like solar air collectors or an electrical heater, provided that the dehydration temperature is reached. Then the air is sent through the reactor to dehydrate the material. The airflow leaving the reactor can also be used to heat fresh air coming from the exterior with the help of a heat exchanger. During sorption (i.e. discharge), moist air is extracted from the

building and passes through the reactor. The water contained in the moist air is used for the hydration of the material. The hot air leaving the reactor is used to heat fresh air.

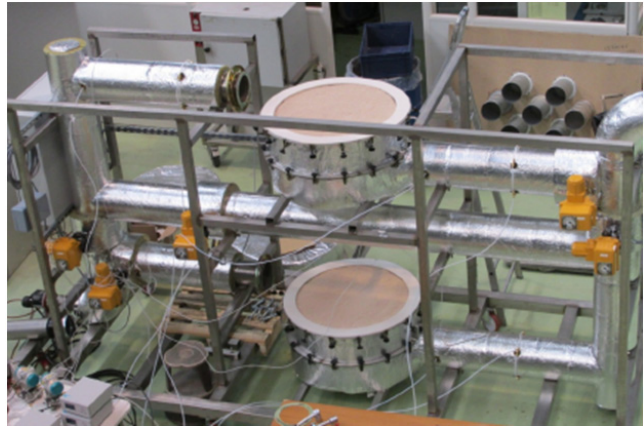
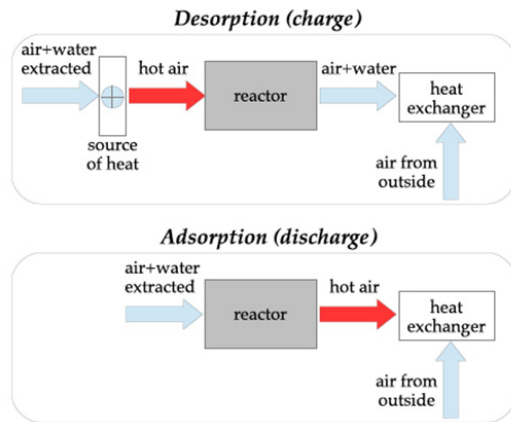

Fig. 11: System integration with storage and release phases

Fig. 12: Picture of the experimental prototype

Zeolite is the material used in the reactor, 80kg. Dealing with the price criteria, Na-X has finally been selected even if a lower heat of hydration than Na-Y (difference about 5%). The whole system consists of two sub-reactors and ducts to drive the airflow into the reactors. The length of the reactors upstream and downstream ducts is ten times their diameter in order to allow a correct measurement of the airflow. Of course an end user system should be more compact. A picture of the reactor is given in Fig. 12. Table 1 shows the experimental conditions during the tests.

Table 1: Experimental conditions of the tests

| Test number | Dehydration | | Hydration | | | Configuration |
|-------------|-------------|------------------------------|-----------|--------|------------------------------|---------------|
| | T [°C] | Flowrate [m ³ /h] | Hr [%] | T [°C] | Flowrate [m ³ /h] | |
| 1 | 180 | 180 | 70 | 20 | 180 | parallel |
| 2 | 180 | 180 | 70 | 20 | 180 | serial |
| 3 | 120 | 180 | 70 | 20 | 180 | parallel |
| 4 | 120 | 180 | 50 | 20 | 180 | parallel |
| 5 | 180 | 120 | 70 | 20 | 120 | parallel |

Fig. 13 shows the evolution of sensible power generated by the TESS according to the test cases. The serial configuration (test 2) is reaching a higher maximum power than the equivalent parallel configuration (test 1). This feature is due to the thermal mass of the second reactor requiring energy from the first one in serial configuration. Hence, serial configuration is not suitable as the maximum power is not constant. Comparing tests 1 and 3, we can observe that decreasing the dehydration temperature leads to decrease the energy but with the same sensible power: duration of maximum is lower for test 3 than for test 1. The maximum power value is 2250 W. The comparison between test 3 and 4 shows the influence of the relative humidity since for test 3 it has been set to 70 % while this value is 50 % for test 4. Thus, the sensible power decreases to 1550 W and the hydration phase is about an hour longer. The results from test 5 show the influence of decreasing the airflow rate to 120 m³ h⁻¹ both for hydration and dehydration phases. Hence, the released energy is the same as test 1 but with a lower maximum power: 1500 W against 2250 W. The hydration phase in this configuration lasts 9 h at the maximum power and decreases to 0 W after 14 h.

The aim of this work was to develop and to characterize a zeolite thermal energy storage system to supply at least 2000 W sensible heating power during 2 h. The experimental results show that it is possible with the designed open

reactor, which provided 2250 W during 6 h, namely 27.5 W kg⁻¹ of material. The reactor size can even be reduced to really meet the requirement of 2 h.

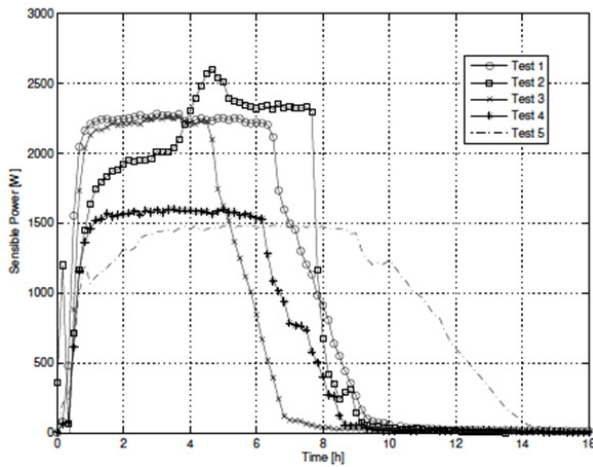

Fig. 13: Sensible power generated by the TESS

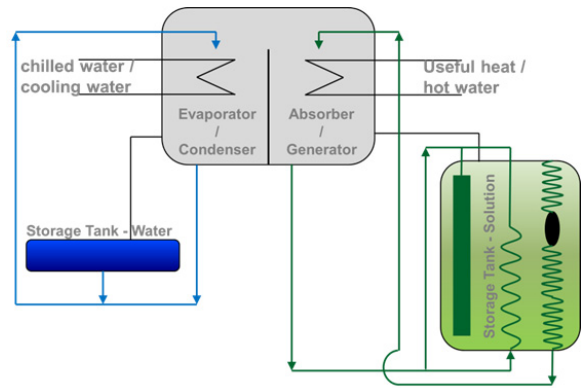

Fig. 14: Scheme of the ZAE Bayern thermochemical heat storage using aqueous LiBr solution

3.7. Thermochemical heat storage using aqueous LiBr solution; ZAE Bayern

A thermochemical heat storage operating equivalent to an absorption heat pump, see Fig. 14. Utilising solar heat (simulated by a gas-fuelled boiler) to charge the storage (i.e. to concentrate the lithium bromide solution by stripping water); during discharging, low temperature heat is used to evaporate the previously stripped water and the vapor is absorbed into the solution, decreasing the concentration of salt and releasing heat which can be used for low temperature heating. The charging power of the system is 6 kW, with charging/discharging temperatures of 70/30 °C; The storage has a total net volume of 0.5 m³ storage material, with 85 kWh storage capacity.

3.8. Long term heat storage with stable supercooled sodium acetate trihydrate; DTU

Sodium acetate trihydrate can be melted by solar energy in the summer. The melted salt can be cooled down to ambient temperature in its liquid phase without solidifying. Utilizing this supercooling effect the heat storage has no heat loss for a period when it rests at ambient temperature. When heat is needed solidification is started and the temperature in the salt increases to the melting temperature of 58 °C. The heat can be discharged and utilized. Fig. 15 illustrates the principle by means of the heat content of sodium acetate trihydrate in the temperature interval from 20°C to 90°C. Different heat storage modules have been tested, both in laboratory heat storage test facilities and as part of a laboratory demonstration system consisting of 22.4 m² solar collectors, a PCM heat storage consisting of 4 modules as shown in Fig. 16 and a buffer tank [10].

The main challenges of the concept are to achieve stable supercooling, reliable activation of solidification, sufficiently high heat exchange capacity rates to and from the heat storage, high enough heat content of the heat storage and long term stability of the heat storage with the high heat content [11].

The ongoing test of the demonstration system will hopefully elucidate that the challenges have been tackled, [12].

Based on the knowledge gained in the projects it is hopefully possible in the future to develop economically attractive compact long term PCM heat storages.

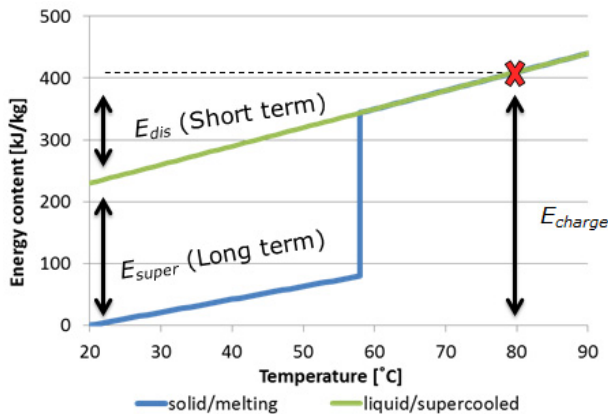

Fig. 15: Heat content of sodium acetate trihydrate in the temperature interval 20°C-90°C.



Fig. 16: PCM heat storage with four modules for the demonstration system.

3.9. PCM in building construction (radiant floor) or in HVAC systems; University of Zaragoza

The project has the aim to implement a thermal energy system (TES) with phase change materials (PCM) system in several applications: the energetic optimization in buildings with the use of PCM in their construction, and the study of the improvement of HVAC systems because of the use of PCM. For this purpose, adequate materials to the studied applications have been searched, and their most important thermophysical properties have been evaluated. All these data will improve the data base available within the research group. Later, the systems have been designed and a prototype of some of them have been built. Simulation has been used as a tool to extrapolate the results to other climates, applications, etc. Finally, an energetic and exergetic evaluation has been done to show the contribution to the energy demand and to the reduction of the ambient impact, also an economic viability analysis has been done. In the next steps, the life cycle analysis will be used to improve the systems.

The technical characteristics of one of the studied systems are: Storage capacity 6.8 kWh/per cycle; 132 kg of PCM; 250 kg overall system mass. First applications foreseen are free cooling or temperature maintenance in rooms (i.e. telecom shelters or similar)

During the project, several challenges came up: trade-off between material properties and system design is a feature (a better designed heat exchange system but with worse PCM -in terms of melting enthalpy and thermal conductivity-, can lead to better thermal performance). To turn some of the PCM based TES solutions more economically feasible, finding low cost PCM can be an issue. Further details can be found in [13], [14] and [15].

3.10. Under floor PCM for residential heating; Chubu University

PCM containers are installed under the floor of a residential house, see Fig. 18. The system will take advantage of the electricity tariff difference between day and night [16]. The phase change material applied is paraffin wax with 25 °C melting temperature. The material is packed in a container of 300 x 300 x 20 mm and is installed in wooden boxes. 90 containers which contain 90 kg of PCM in total were connected in series under the floor of the house. During night time when discount tariff is offered, an air conditioner is in operation, charging the PCM containers. From 7:00 in the morning, a fan is turned on to circulate the air through the house for discharging. Demonstration houses are built in Nagano city and Aichi prefecture in Japan.

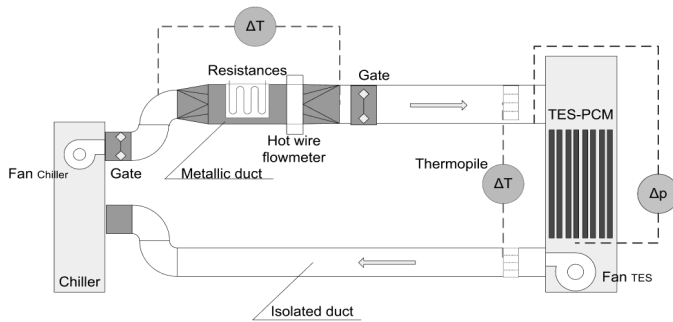

Fig. 17: Experimental setup to test real scale PCM-Air TES systems.

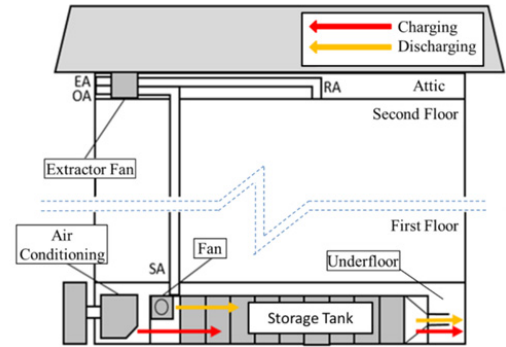

Fig. 18: Schematic of the underfloor PCM storage system

3.11. Compact latent heat TES for micro-cogeneration plants; University of the Basque Country

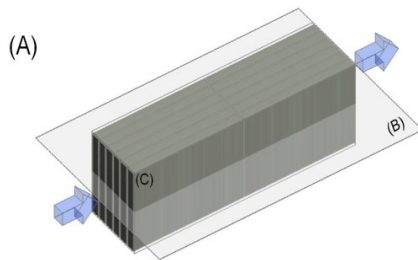

Fig. 19: Schematic view of a stack consisting of 12 plates (6 in parallel and 2 in series)

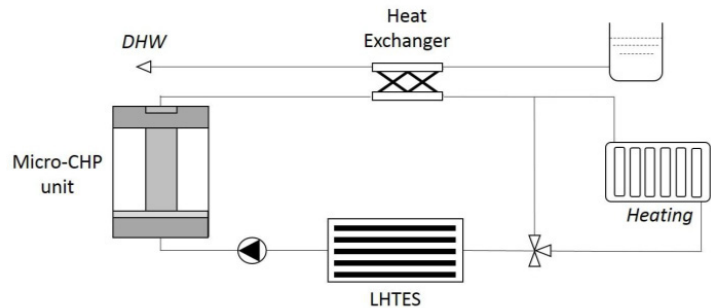

Fig. 20: Schematic view of the latent heat TES integration within the micro-CHP installation

The aim of the project is to develop a modular latent heat thermal energy storage system based on plates for its integration within micro-cogeneration (micro-CHP) plants. The plates are made of hollow aluminium filled with PCM. The HTF (water) flows in laminar regime through the spaces between the parallel plates exchanging heat with the PCM by the plate surfaces. The plates are grouped in stacks as it can be seen in Fig. 19. The modular nature of the stacks of plates makes the solution very suitable for applications with different constraints, such as volume, capacity, power, maximum admissible discharging time, etc. The solution can be also integrated in other intermittent applications, for example thermal solar, waste heat, etc.

Fig. 20 represents the integration of the latent heat TES system within the micro-CHP plant. It is placed in series at the return from the consumption (space heating and domestic hot water DHW). Thus, the system stores the surplus heat that is not consumed by the user, storing at full load at those moments with the micro-CHP operating with no demand. It can be seen that the domestic hot water (DHW) production has priority over the heating load, being produced by a plate heat exchanger. More information about the latent heat TES system and the integration into micro-CHP plants can be found in [17] and [18].

RT60 PCM by Rubitherm GmbH was selected as the latent storage medium with a phase change around 60°C. The design parameters are the following: 4.1 kW charging (at 65°C), 3.4 kW discharging (at 50°C); and 0.3 m³ volume with about 7.2 kWh capacity. Though experiments have been done at laboratory scale, the full scale LHTES prototype is currently under construction. The plate based latent heat TES system prototype will be included in a micro-CHP plant and tested under real operation conditions.

4. Storage applications for industry

4.1. Mobile sorption heat storage for industrial waste heat recovery, ZAE Bayern

A zeolite sorption storage, mounted on a semi-trailer, is charged using heat from a waste incineration plant, and driven to an industrial drying process in about 8 km distance, where the heat is released, substituting natural gas. The storage is charged by applying a hot airstream to the system, thus drying the zeolite. Discharging mode requires a moist airstream, which is dried and heated up by passing through the packed bed of zeolite. The operation conditions determine the water content of the zeolite at the charging and discharging cycle, which are important parameters for the energy capacity of the storage. Low invest costs, a short distance between charging and discharging station, a high energy capacity of the storage, and a customer with an almost constant annual heat demand are required to operate a mobile sorption storage system competitively [19].

The input temperatures to the storage are 250°C and 60 °C for charging and discharging, respectively. A peak power of 300 kW can be provided for about 8 hours during discharging. Each storage container contains 22 m³ of heat storage material. The storage capacity under the given reference conditions is 4,600 kWh per container.

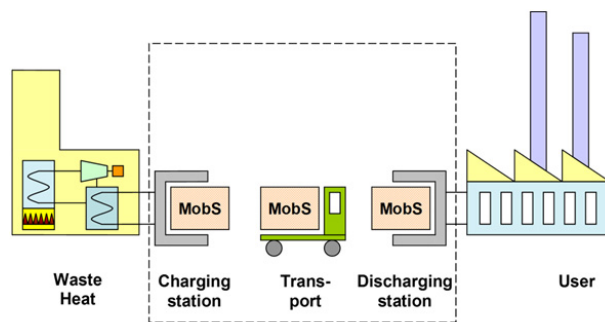

Fig. 21: Principle of mobile sorption heat storage in industrial waste heat recovery



Fig. 22: Macroscopic encapsulated PCM for mobile latent thermal energy storage of University of Bayreuth

4.2. Development of macro-encapsulated latent heat storage for the transport of heat, University of Bayreuth

The latent thermal energy storage system is designed for mobile applications. It consists of a 20 feet long ISO container that is transportable with motor trucks.

Table 2: Key parameters of the previous storage container

| | |
|--|-------------|
| Inlet temperature (charging/discharging) | 90 / 40 °C |
| Discharging power (final/initial) | 50 / 350 kW |
| Storage capacity (between 40 and 90 °C) | 2300 kWh |

Based on an already existing design with the key parameters shown in Table 2, an improved storage unit is evolved. For a considerably higher charging and discharging power the heat exchanger surface is increased by macro encapsulation see Fig. 22. The range of applications of this mobile latent heat storage device is highly expanded by applying PCM with melting temperatures between 70 °C and 150 C and the utilization of thermally stable metallic encapsulation materials [20]. Heat sources are for instance industrial waste heat. The previous storage system based on sodium acetate tri-hydrate with its low melting point of 58 °C is suitable only for the supply

of few specific heat sinks, e.g. for heating swimming pool water. The new system will be able to provide heat at a temperature level suitable for process heat applications.

5. Conclusions

One of the main elements in the work of T4229 was the further development of system applications for compact thermal energy storage in three temperature fields: low temperatures for cooling, medium temperatures for room heating and domestic hot water and high temperatures for industry. A large number of groups worked on these applications and their work provided inputs for validation of numerical models and boundary conditions for the further and more targeted development of materials.

Considerable progress was made on a broad range in the development of components and systems, providing knowledge and experience regarding the design, numerical modeling, building, testing and economical assessing of components and storage systems. The vast amount of knowledge and experience that was gained by the different projects, lead to the following conclusions.

The interaction between the storage materials and the materials of the system components can be deciding for the technical feasibility of the combination. Therefore, more targeted development of components should be done in combination with the storage material.

A number of components appeared to be less understood than initially thought. This concerns especially reactors, heat exchangers and evaporators for water under low pressure. These components need targeted attention for further research and development.

The inclusion of storage materials in components or systems generate new challenges like the occurrence of non-condensable gases and thermomechanical effects. To circumvent or prevent these, novel technologies have to be sought and applied in the components design.

Especially for thermochemical technologies, new technologies to determine the state of charge of the storage need to be developed.

In order to obtain a better comparison between system performance of different technologies, more standardized and simplified system approaches are needed.

Additionally, long term testing under real operating conditions (high level integration) will be fundamental for the implementation of novel TES approaches. This will have to assess the interaction between the TES system and the rest of the components through the lifespan of the whole application.

And in general, the development of all components and system configurations should be more aimed at cost reduction of the final system.

Acknowledgements

The financial supports of the European Commission for subsidizing the COMTES project within the 7th framework program for research is acknowledged.

The University of Bayreuth sincerely thanks the Federal Ministry of Economic Affairs and Energy (BMWi), Germany for the research funding and support.

The work of ZAE Bayern was supported by the German Federal Ministry for Economic Affairs and Energy (BMWi) under the project code 0327383B, and by the Federal Ministry for the Environment, Nature Conservation and Nuclear Safety (BMU) under the project codes 0329605O and 0325978A.

The university of Zaragoza thanks the Spanish Government for the partial funding of this work within the framework of research projects ENE2008-06687-C02-02, ENE2011-28269-C03-01 and ENE2014-57262-R. Special thanks are extended to Miguel Zamora, CIAT R&D Manager, for his collaboration.

The LOCIE laboratory thanks the ANR (French National Research Agency) for its financial support under the research projects PROSIS2 ANR-11-SEED-0011-01.

The University of the Basque Country acknowledges the financial support of the Spanish Ministry of Economy and Competitiveness through the MicroTES (ENE2012-38633) research project.

The research leading to the results of MERITS has received funding from the European Commission Seventh Framework Programme (FP/2007-2013) under grant agreement No ENER/FP7/295983 (MERITS).

References

- [1] Andreas Hauer, The 4-temperature approach – A method to evaluate new materials for thermochemical heat storage under application conditions.
- [2] M. Helm, K. Hagel, W. Pfeffer, S. Hiebler, C. Schweigler, Solar Heating and Cooling System with Absorption Chiller and Latent Heat Storage – A Research Project Summary, *Energy Procedia* 48 (2014) 837-849
- [3] B. Fumey, R. Weber, P. Gantenbein, X. Daguene-Frick, T. Williamson, V. Dorer,, Closed sorption heat storage based on aqueous sodium hydroxide, SHC2013 Germany, *Energy Procedia* 48 (2014) 337 – 346
- [4] X. Daguene-Frick, P. Gantenbein, E. Frank, B. Fumey, R. Weber, T. Williamson. Development of a numerical model for the reaction zone design of an aqueous sodium hydroxide seasonal thermal energy storage. *Solar Energy, ISES Solar World Congress 2013 (SWC2013) Special Issue* 121, 17–30. doi:10.1016/j.solener.2015.06.009
- [5] B. Fumey; R. Weber; P. Gantenbein; X. Daguene-Frick; Sascha Stoller; Reto Fricker; V. Dorer, Operation results of a closed sorption heat storage prototype, IRES2015, Germany. *Energy Procedia* 73 (2015) 324 – 330
- [6] Huaylla F., Le Pierrès N., Stutz B., Performance analysis of multifunctional exchangers implemented in an interseasonal sorption heat storage system, ISHPC (International Sorption Heat Pump Conference), Maryland (USA), March 31- April 3 2014
- [7] Huaylla F., Le Pierrès N., Stutz B., Numerical and experimental analysis of an absorption reactor using LiBr/H₂O for solar heat long-term storage, ECCE10 (10th European Congress of Chemical Engineering), Nice (France), September 27-October 1 2015
- [8] Jong Aj de, Finck C, Oversloot H, Spijker H van 't, Cuypers R, Thermochemical heat storage (TCS) - system design issues, *Energy Procedia* 2014; 48: 309 – 319.
- [9] Roelands M, Cuypers R, Kruit K, Oversloot H, Jong AJ de, Spijker H van 't, Duvalois W, Vliet L van, Hoegaerts C, Preparation & characterization of sodium sulfide hydrates for application in thermochemical storage systems, *Energy Procedia* 2015; 70: 257 – 266.
- [10] M. Dannemand, W. Kong, J. Fan, J.B. Johansen, S. Furbo, Laboratory Test of a Prototype Heat Storage Module Based on Stable Supercooling of Sodium Acetate Trihydrate, in: *Energy Procedia, Elsevier B.V.*, 2015: pp. 172–181. doi:10.1016/j.egypro.2015.02.113.
- [11] M. Dannemand, J.M. Schultz, J.B. Johansen, S. Furbo, Long term thermal energy storage with stable supercooled sodium acetate trihydrate, *Appl. Therm. Eng.* 91 (2015) 671–678. doi:10.1016/j.applthermaleng.2015.08.055.
- [12] J. Berg Johansen, M. Dannemand, W. Kong, G. Englmair, J. Fan, J. Dragsted, B. Perers, S. Furbo. Practical application of compact long term heat storage. Laboratory testing of solar combi system with compact long term PCM heat storage. SHC Conference 2015, Istanbul Turkey.
- [13] A. Lázaro, P. Dolado, J.M. Marín, B. Zalba. PCM-air heat exchangers for free-cooling applications in buildings: Experimental results of two real-scale prototypes. *Energy Conversion and Management, Volume 50, Issue 3, March 2009, Pages 439-443.*
- [14] P. Dolado, A. Lázaro, J.M. Marín, B. Zalba. “Characterization of melting and solidification in a real scale PCM-air heat exchanger: Experimental results and empirical model”, *Renewable Energy, Volume 36, Issue 11, November 2011, Pages 2906-2917. DOI: 10.1016/j.renene.2011.04.008*
- [15] J. Mazo, M. Delgado, J. M. Marín, B. Zalba. “Modeling a radiant floor system with Phase Change Material (PCM) integrated into a building simulation tool: Analysis of a case study of a floor heating system coupled to a heat pump”, *Energy and Buildings, Volume 47, April 2012, Pages 458-466. DOI:10.1016/j.enbuild.2011.12.022*
- [16] Lun wan, Motoi Yamaha, Hideki Takamura and Aya Yokoe, A study on thermal characteristics of a latent heat storage tank placed under floor of a residential house Part 1: Measurement of Phase Change Material and Thermal Response of a Tank, *Greenstock 2015, 13th international conference on thermal energy storage, 2015*
- [17] Campos-Celador A, Diarce G, González-Pino I, Sala JM. Development and comparative analysis of the modelling of an innovative finned plate latent heat thermal energy storage system. *Energy* 2013; 58: 438-447.
- [18] Campos-Celador A, González-Pino I, Bandos TV. Simulation of a latent heat thermal storage system within a Stirling based micro-CHP residential installation. *Proceedings of the 16th ISEC International Stirling Engine Conference (Bilbao) 2014.*
- [19] A. Krönauer, E. Lävemann, S. Brückner, M. Gaaß, M. Treder, B. Kinzel, A. Hauer, Mobile Sorptionspeicher zur industriellen Abwärmenutzung, Grundlagen und Demonstrationsanlage (MobS II), final report, available from: <http://www.tib.uni-hannover.de/en.html>
- [20] S. Höhle, A. König-Haagen, D. Brüggemann: "EXPERIMENTAL INVESTIGATION ON PHASE CHANGE MATERIALS (PCM) FOR MOBILE HEAT STORAGE DEVICES"; Poster session presented at: 10th International Renewable Energy Storage Conference (IRES 2016), 2016 March 15-17; Düsseldorf, Germany.